

THIS DRAWING IS UNPUBLISHED. RELEASED FOR PUBLICATION 20
 © COPYRIGHT 20 BY - ALL RIGHTS RESERVED.

LOC		DIST		REVISIONS			
P	LTR	DESCRIPTION		DATE	DWN	APVD	
	A	FIRST RELEASE		15FEB2012	RC	EK	
	A1	ECR-12-016253		12SEP2012	W.W	YH.M	
	A2	ECR-12-021134		12NOV2012	W.W	YH.M	
	A3	ECR-13-001507		25JAN2013	W.W	YH.M	

NOTE

- SEE SHEET 4 FOR AVAILABLE CONFIGURATIONS
- MATERIAL: HOUSING, NYLON, UL94 V0, 750°C GWT NO FLAME EIGHT COLORS AVAILABLE, INCLUDING: NATURAL, RED, BLUE, YELLOW, BLACK, GREY, GREEN, PURPLE WHITE VERSION IS PRELIMINARY CONTACT, COPPER ALLOY, 0.60MM THICK
- FINISH: OPTION 1: TIN PLATING OVER NICKEL UNDERPLATING OPTION 2: AG PLATING OVER NICKEL UNDERPLATING
- PCB LAYOUT AS SHOWN
- THE PART NUMBERS SHOWING IN SHEET 2 & 3 & 4 ARE FOR NATURAL COLOR. THE PART NUMBER FOR OTHER COLOR ARE BASED ON THE NATURAL ONE: FOR THE SAME CONFIGURATION, THE PREFIX AND POSTFIX OF THE P/N ARE THE SAME, ONLY THE BASE NUMBER IS DIFFERENT ACCORDING TO DIFFERENT COLOR, DETAIL PLEASE SEE SHEET 5
- PACKAGING: LOOSE PIECE OR TUBE. THE PART NUMBERS IN THIS DRAWING ARE WITH LOOSE PIECE PACKAGING. PLEASE CONTACT TE SALES REPRESENTATIVES FOR TUBE PACKAGING REQUIREMENT.

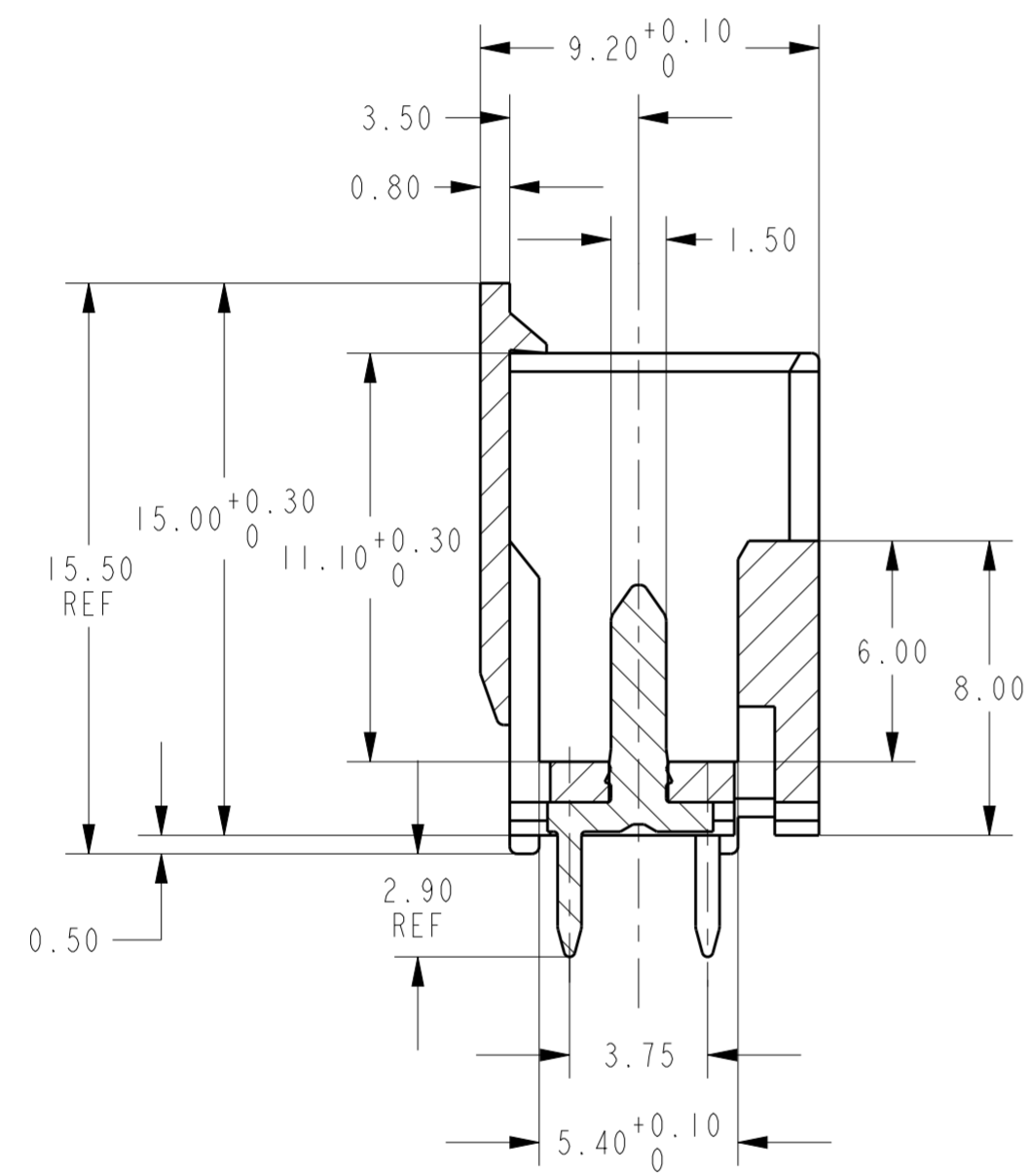
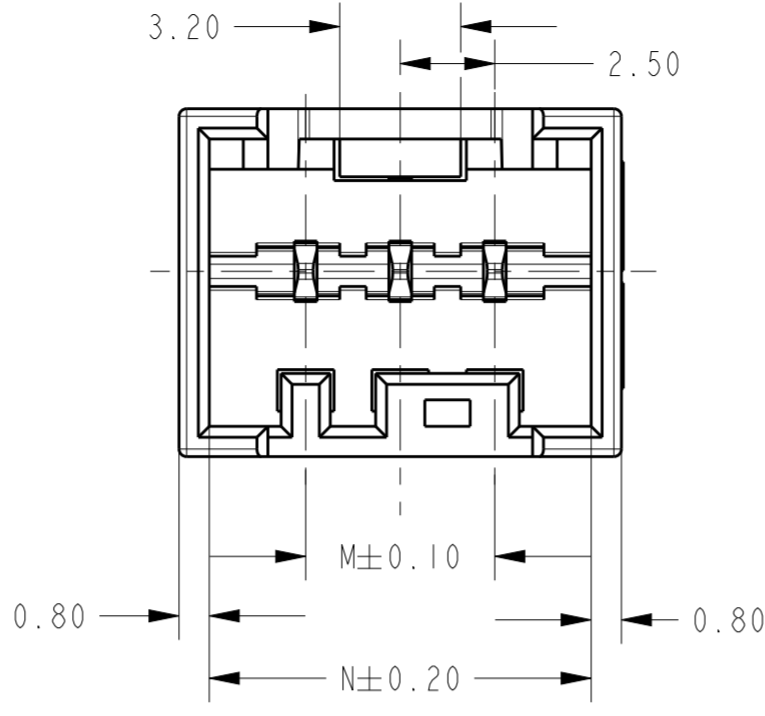

SECTION A-A

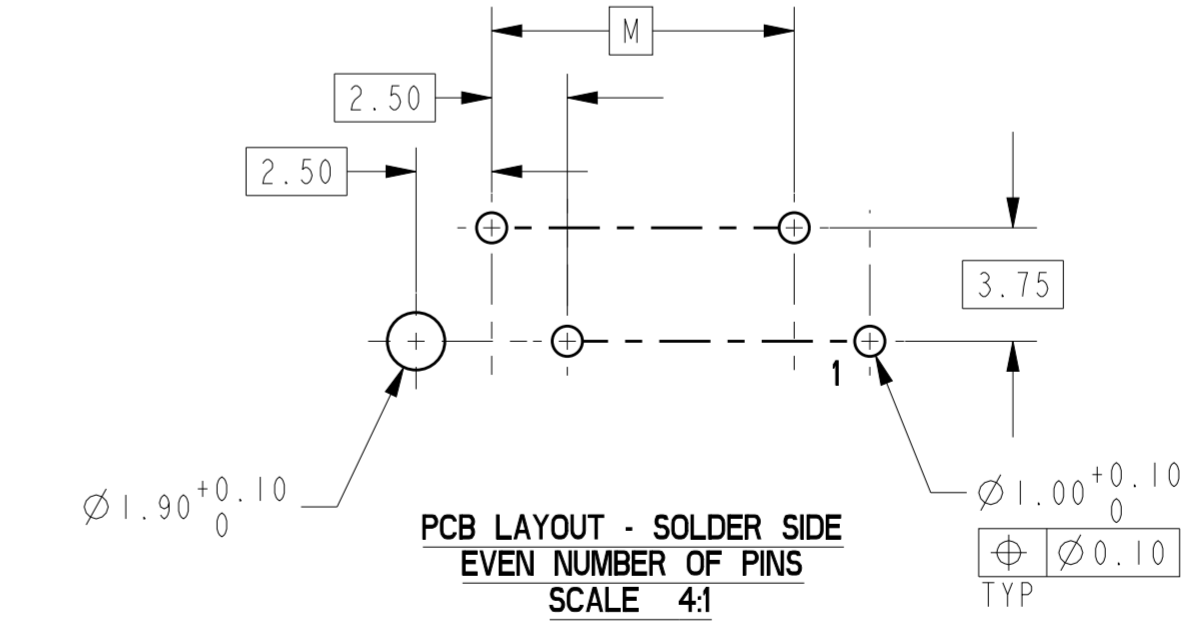
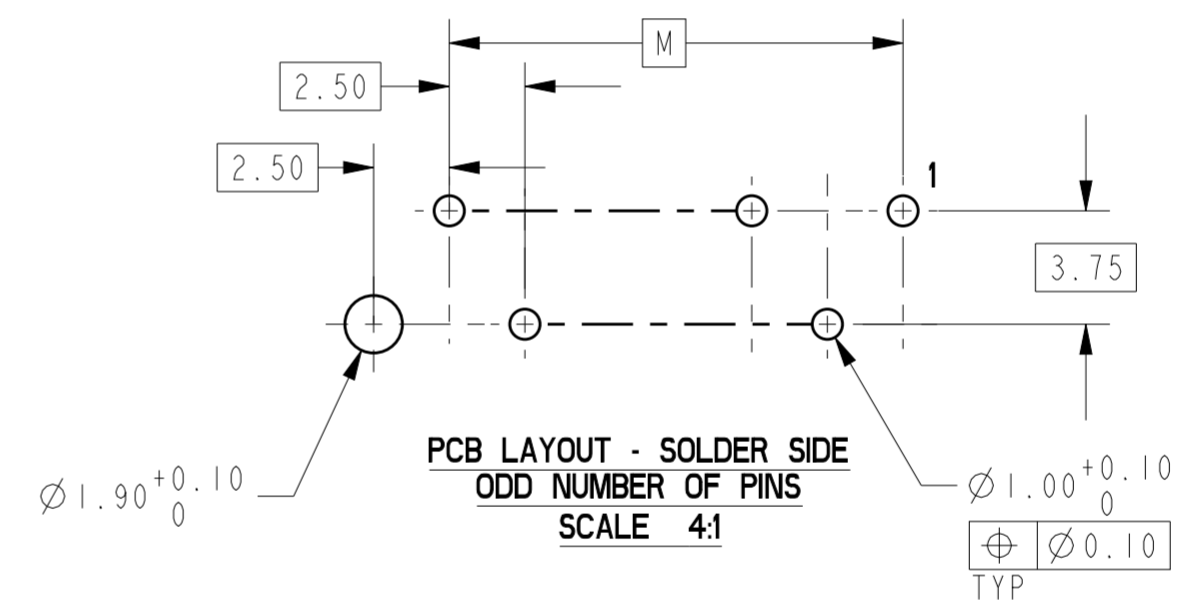
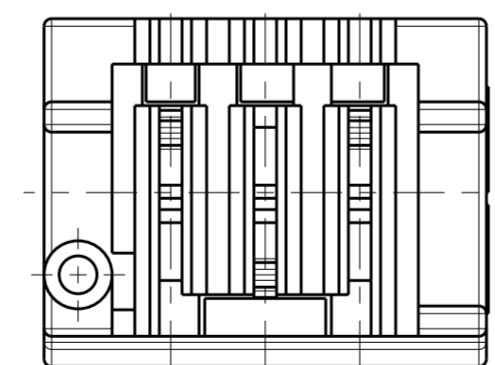
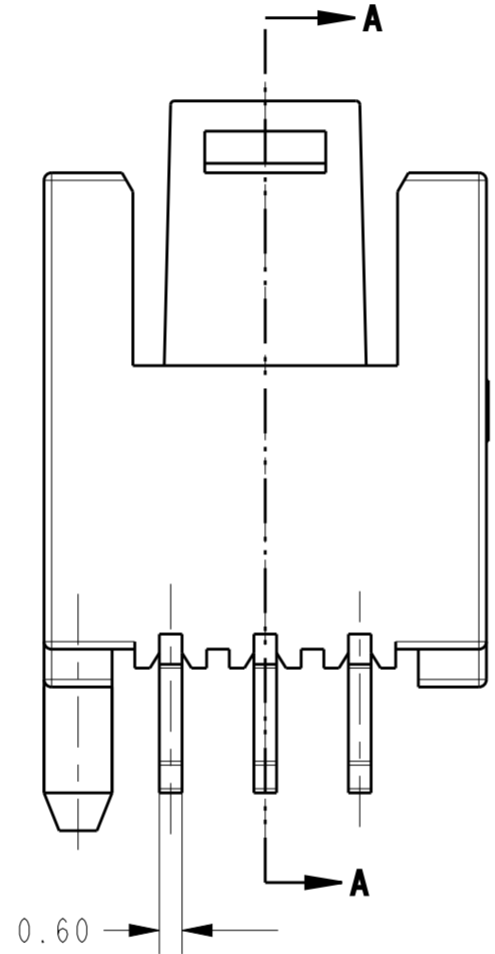

40.10	35.00	15
37.60	32.50	14
35.10	30.00	13
32.60	27.50	12
30.10	25.00	11
27.60	22.50	10
25.10	20.00	9
22.60	17.50	8
20.10	15.00	7
17.60	12.50	6
15.10	10.00	5
12.60	7.50	4
10.10	5.00	3
N	M	NO. OF POS.

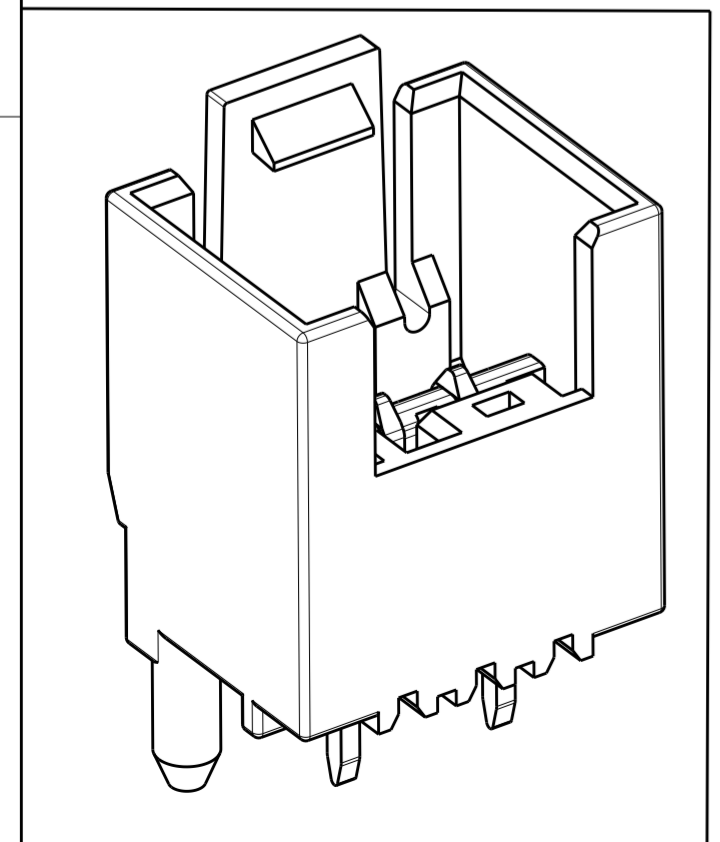

THIS DRAWING IS A CONTROLLED DOCUMENT.		DWN: WINTER WANG 12NOV2012	TE Connectivity	
		CHK: HAPYE WU 12NOV2012		
		APVD: YUHONG MAO 12NOV2012	NAME: RAST 2.5 TAB HEADER ASSY TH, VERTICAL, EXTERNAL LOCKING	
DIMENSIONS: mm		PRODUCT SPEC: 108-106079	SIZE: A2	
TOLERANCES UNLESS OTHERWISE SPECIFIED:		APPLICATION SPEC: -	CAGE CODE: 00779	
0 PLC ±		WEIGHT: -	DRAWING NO: C-1971817	
1 PLC ±		CUSTOMER DRAWING	RESTRICTED TO: -	
2 PLC ±0.20		SCALE: NTS	SHEET 1 OF 5	
3 PLC ±			REV: A3	
4 PLC ±				
ANGLES ±1°				
FINISH				

THIS DRAWING IS UNPUBLISHED. RELEASED FOR PUBLICATION 20
 © COPYRIGHT 20 BY - ALL RIGHTS RESERVED.





LOC		DIST		REVISIONS			
P	LTR	DESCRIPTION	DATE	DWN	APVD		
-	-	SEE SHEET 1	-	-	-		

QTY	TAB CONTACT	QTY	HOUSING	POS.	TE PART NO.	QTY	TAB CONTACT	QTY	HOUSING	POS.	TE PART NO.		
15	TAB CONTACT w/ SILVER PLATING	1	RAST 2.5 TAB HEADER HOUSING, EXTERNAL LOCKING, 15P (SEE THE DETAIL LAYOUT ON SHEET 4)	15	3-1971838-5 2-1971838-5 1-1971838-5	4	TAB CONTACT w/ SILVER PLATING	1	RAST 2.5 TAB HEADER HOUSING, EXTERNAL LOCKING, 10P (SEE THE DETAIL LAYOUT ON SHEET 4)	10	3-1971837-0 2-1971837-0 1-1971837-0		
14		1	RAST 2.5 TAB HEADER HOUSING, EXTERNAL LOCKING, 14P (SEE THE DETAIL LAYOUT ON SHEET 4)	14	1-1971838-4	6		1	RAST 2.5 TAB HEADER HOUSING, EXTERNAL LOCKING, 9P (SEE THE DETAIL LAYOUT ON SHEET 4)	9	6-1971837-9 5-1971837-9 4-1971837-9 3-1971837-9 2-1971837-9 1-1971837-9		
13		1	RAST 2.5 TAB HEADER HOUSING, EXTERNAL LOCKING, 13P (SEE THE DETAIL LAYOUT ON SHEET 4)	13	1-1971838-3	9		1	RAST 2.5 TAB HEADER HOUSING, EXTERNAL LOCKING, 8P (SEE THE DETAIL LAYOUT ON SHEET 4)	8	3-1971837-8 2-1971837-8 1-1971837-8		
8		1	RAST 2.5 TAB HEADER HOUSING, EXTERNAL LOCKING, 12P (SEE THE DETAIL LAYOUT ON SHEET 4)	12	2-1971838-2 1-1971838-2	8		1	RAST 2.5 TAB HEADER HOUSING, EXTERNAL LOCKING, 7P (SEE THE DETAIL LAYOUT ON SHEET 4)	7	7-1971837-7 6-1971837-7 5-1971837-7 4-1971837-7 3-1971837-7 2-1971837-7 1-1971837-7		
12		1	RAST 2.5 TAB HEADER HOUSING, EXTERNAL LOCKING, 11P (SEE THE DETAIL LAYOUT ON SHEET 4)	11	2-1971838-1 1-1971838-1	7		1	RAST 2.5 TAB HEADER HOUSING, EXTERNAL LOCKING, 6P (SEE THE DETAIL LAYOUT ON SHEET 4)	6	4-1971837-6 3-1971837-6 2-1971837-6 1-1971837-6		
11		1	RAST 2.5 TAB HEADER HOUSING, EXTERNAL LOCKING, 11P (SEE THE DETAIL LAYOUT ON SHEET 4)	11	2-1971838-1 1-1971838-1	6		1	RAST 2.5 TAB HEADER HOUSING, EXTERNAL LOCKING, 5P (SEE THE DETAIL LAYOUT ON SHEET 4)	5	4-1971837-5 3-1971837-5 2-1971837-5 1-1971837-5		
QTY		TAB CONTACT	QTY	HOUSING	POS.	TE PART NO.		QTY	TAB CONTACT	QTY	HOUSING	POS.	TE PART NO.

THIS DRAWING IS A CONTROLLED DOCUMENT.		DWN WINTER WANG 12NOV2012	 TE Connectivity NAME RAST 2.5 TAB HEADER ASSY TH, VERTICAL, EXTERNAL LOCKING				
DIMENSIONS: mm		CHK HAPYE WU 12NOV2012					
TOLERANCES UNLESS OTHERWISE SPECIFIED:		APVD YUJHONG MAO 12NOV2012					
0 PLC ± 1 PLC ± 2 PLC ±0.20 3 PLC ± 4 PLC ± ANGLES ±1° FINISH		PRODUCT SPEC - APPLICATION SPEC -					
MATERIAL	-	WEIGHT	-	SIZE A2	CAGE CODE 00779	DRAWING NO C-1971817	RESTRICTED TO -
CUSTOMER DRAWING				SCALE NTS	SHEET 2	OF 5	REV A3

THIS DRAWING IS UNPUBLISHED. RELEASED FOR PUBLICATION 20
 © COPYRIGHT 20 BY - ALL RIGHTS RESERVED.

LOC	DIST	REVISIONS					
ES	00	P	LTR	DESCRIPTION	DATE	DWN	APVD
		-		SEE SHEET 1		-	-

QTY	TAB CONTACT	QTY	HOUSING	POS.	TE PART NO. 	QTY	TAB CONTACT	QTY	HOUSING	POS.	TE PART NO. 		
15	TAB CONTACT w/ TIN PLATING	1	RAST 2.5 TAB HEADER HOUSING, EXTERNAL LOCKING, 15P (SEE THE DETAIL LAYOUT ON SHEET 4)	15	3-1971818-5 2-1971818-5 1-1971818-5	4	TAB CONTACT w/ TIN PLATING	1	RAST 2.5 TAB HEADER HOUSING, EXTERNAL LOCKING, 10P (SEE THE DETAIL LAYOUT ON SHEET 4)	10	3-1971817-0 2-1971817-0 1-1971817-0		
14		1	RAST 2.5 TAB HEADER HOUSING, EXTERNAL LOCKING, 14P (SEE THE DETAIL LAYOUT ON SHEET 4)	14	1-1971818-4	6		1	RAST 2.5 TAB HEADER HOUSING, EXTERNAL LOCKING, 9P (SEE THE DETAIL LAYOUT ON SHEET 4)	9	6-1971817-9 5-1971817-9 4-1971817-9 3-1971817-9 2-1971817-9 1-1971817-9		
13		1	RAST 2.5 TAB HEADER HOUSING, EXTERNAL LOCKING, 13P (SEE THE DETAIL LAYOUT ON SHEET 4)	13	1-1971818-3	9		1	RAST 2.5 TAB HEADER HOUSING, EXTERNAL LOCKING, 8P (SEE THE DETAIL LAYOUT ON SHEET 4)	8	3-1971817-8 2-1971817-8 1-1971817-8		
8		1	RAST 2.5 TAB HEADER HOUSING, EXTERNAL LOCKING, 12P (SEE THE DETAIL LAYOUT ON SHEET 4)	12	2-1971818-2 1-1971818-2	8		1	RAST 2.5 TAB HEADER HOUSING, EXTERNAL LOCKING, 7P (SEE THE DETAIL LAYOUT ON SHEET 4)	7	7-1971817-7 6-1971817-7 5-1971817-7 4-1971817-7 3-1971817-7 2-1971817-7 1-1971817-7		
12		1	RAST 2.5 TAB HEADER HOUSING, EXTERNAL LOCKING, 11P (SEE THE DETAIL LAYOUT ON SHEET 4)	11	2-1971818-1 1-1971818-1	7		1	RAST 2.5 TAB HEADER HOUSING, EXTERNAL LOCKING, 6P (SEE THE DETAIL LAYOUT ON SHEET 4)	6	4-1971817-6 3-1971817-6 2-1971817-6 1-1971817-6		
11		1	RAST 2.5 TAB HEADER HOUSING, EXTERNAL LOCKING, 11P (SEE THE DETAIL LAYOUT ON SHEET 4)	11	2-1971818-1 1-1971818-1	6		1	RAST 2.5 TAB HEADER HOUSING, EXTERNAL LOCKING, 5P (SEE THE DETAIL LAYOUT ON SHEET 4)	5	4-1971817-5 3-1971817-5 2-1971817-5 1-1971817-5		
QTY		TAB CONTACT	QTY	HOUSING	POS.	TE PART NO. 		QTY	TAB CONTACT	QTY	HOUSING	POS.	TE PART NO. 

THIS DRAWING IS A CONTROLLED DOCUMENT.

DWN: WINTER WANG 12NOV2012
 CHK: HAPYE WU 12NOV2012
 APVD: YUHONG MAO 12NOV2012

STE TE Connectivity

NAME: RAST 2.5 TAB HEADER ASSY TH, VERTICAL, EXTERNAL LOCKING

PRODUCT SPEC: -
 APPLICATION SPEC: -
 WEIGHT: -

SIZE: A2 CAGE CODE: 00779 DRAWING NO: C-1971817 RESTRICTED TO: -
 SCALE: NTS SHEET 3 OF 5 REV A3

CUSTOMER DRAWING

REVISONS		DATE	OWN	APVD
LOC	DIST			
-	-			
P LTH		DESCRIPTION		
-		SEE SHEET 1	-	-

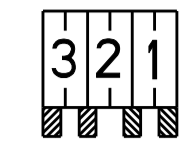

1-1971817-3
 1-1971837-3

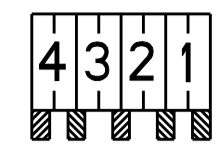

1-1971817-4
 1-1971837-4

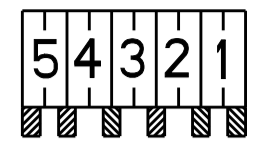

1-1971817-5
 1-1971837-5

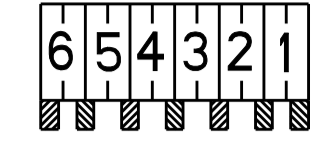

1-1971817-6
 1-1971837-6

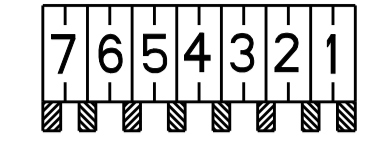

1-1971817-7
 1-1971837-7



1-1971817-8
 1-1971837-8

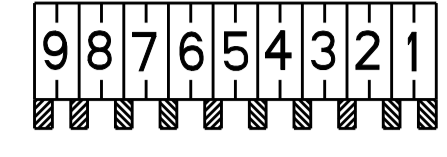

1-1971817-9
 1-1971837-9

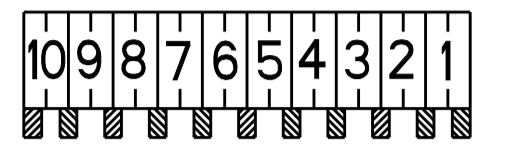

1-1971817-0
 1-1971837-0

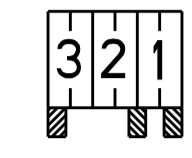

2-1971817-3
 2-1971837-3

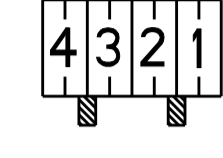

2-1971817-4
 2-1971837-4

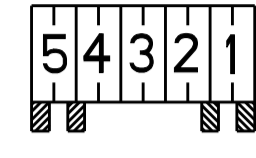

2-1971817-5
 2-1971837-5

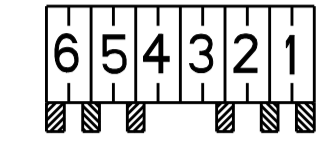

2-1971817-6
 2-1971837-6

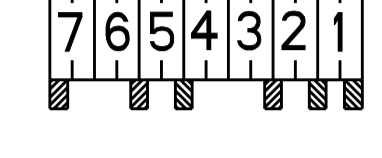

2-1971817-7
 2-1971837-7

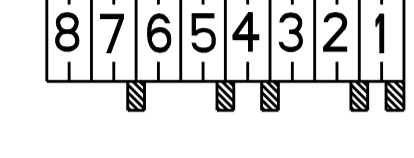

2-1971817-8
 2-1971837-8



2-1971817-9
 2-1971837-9



2-1971817-0
 2-1971837-0

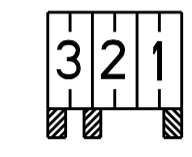

3-1971817-3
 3-1971837-3

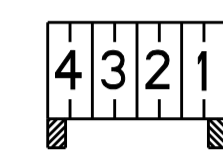

3-1971817-4
 3-1971837-4

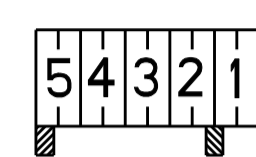

3-1971817-5
 3-1971837-5

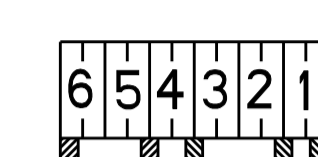

3-1971817-6
 3-1971837-6

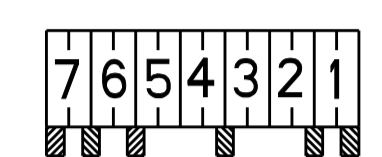

3-1971817-7
 3-1971837-7

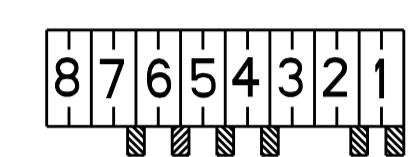

3-1971817-8
 3-1971837-8

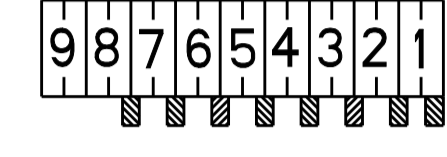

3-1971817-9
 3-1971837-9

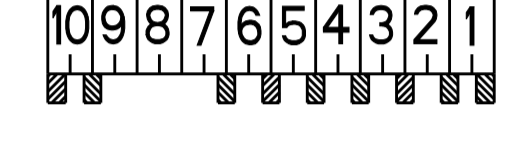

3-1971817-0
 3-1971837-0

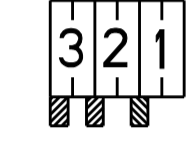

4-1971817-3
 4-1971837-3

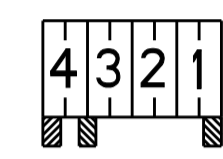

4-1971817-4
 4-1971837-4

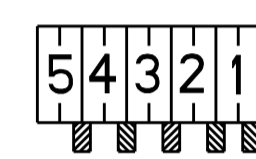

4-1971817-5
 4-1971837-5

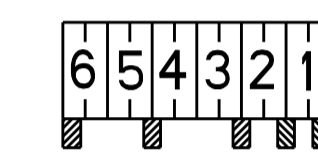

4-1971817-6
 4-1971837-6

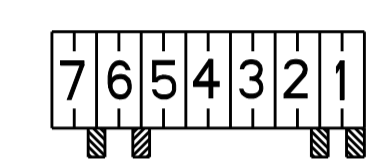

4-1971817-7
 4-1971837-7



4-1971817-8
 4-1971837-8

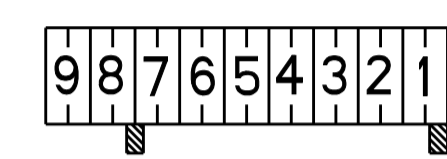

4-1971817-9
 4-1971837-9

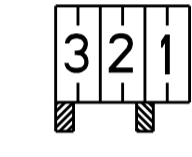

5-1971817-3
 5-1971837-3

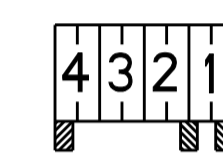

5-1971817-4
 5-1971837-4



5-1971817-5
 5-1971837-5

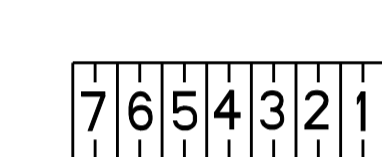

5-1971817-7
 5-1971837-7



5-1971817-9
 5-1971837-9



6-1971817-3
 6-1971837-3

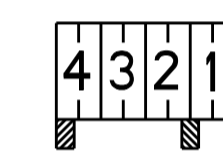

6-1971817-4
 6-1971837-4



6-1971817-5
 6-1971837-5

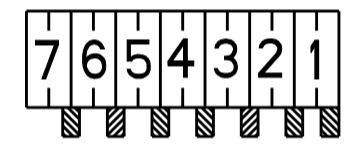

6-1971817-7
 6-1971837-7

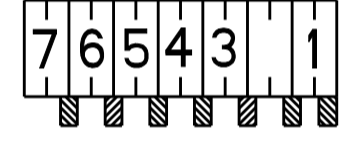

7-1971817-7
 7-1971837-7



6-1971817-9
 6-1971837-9

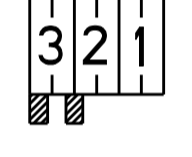

7-1971817-3
 7-1971837-3

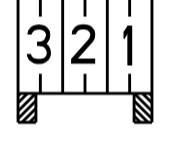

9-1971817-3
 9-1971837-3



8-1971817-3
 8-1971837-3

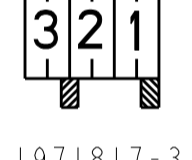

1971817-3
 1971837-3

4 POS

5 POS

6 POS

7 POS

8 POS

9 POS

10 POS

3 POS

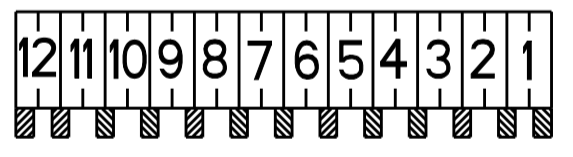

1-1971818-2
 1-1971838-2

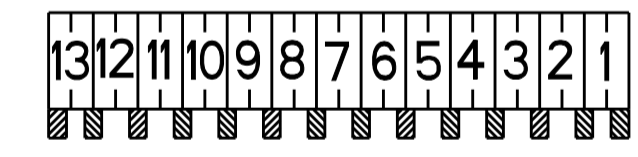

1-1971818-3
 1-1971838-3

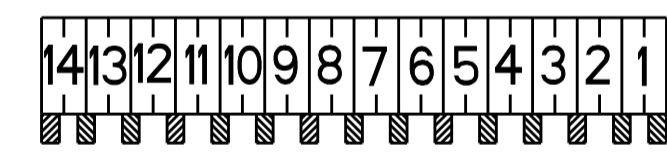

1-1971818-4
 1-1971838-4

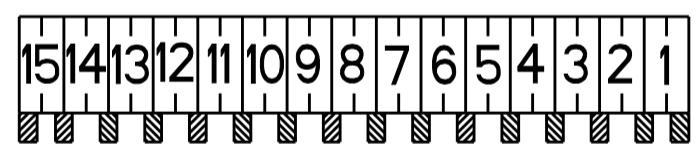

1-1971818-5
 1-1971838-5

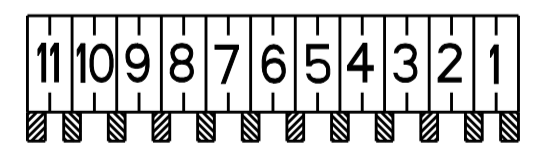

1-1971818-1
 1-1971838-1

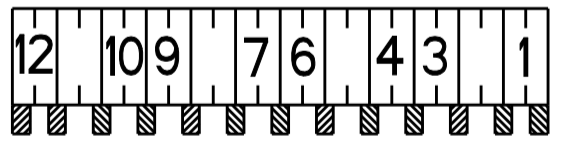

2-1971818-2
 2-1971838-2

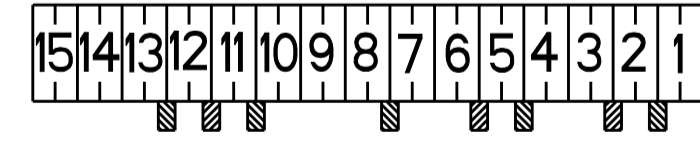

2-1971818-5
 2-1971838-5

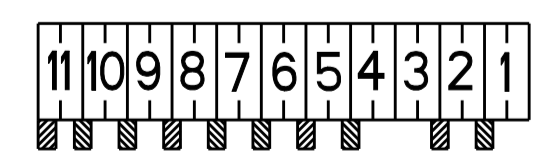

2-1971818-1
 2-1971838-1

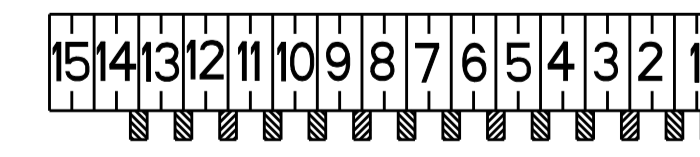

3-1971818-5
 3-1971838-5

11 POS

12 POS

13 POS

14 POS

15 POS

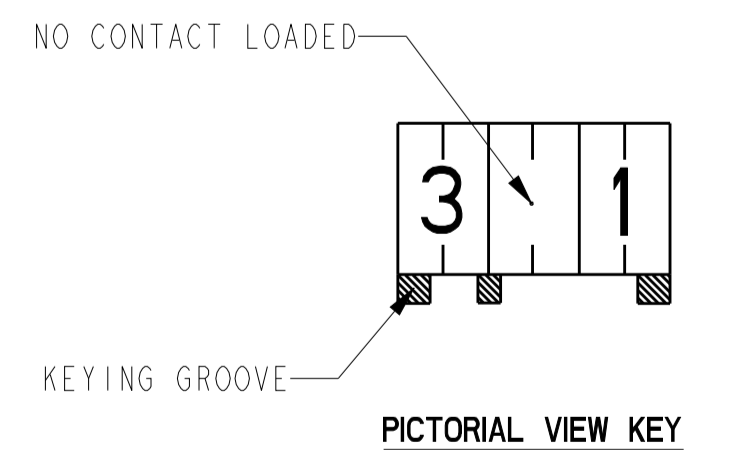

THIS DRAWING IS A CONTROLLED DOCUMENT.		OWN: WINTER WANG CHK: HAPYE WU APVD: YUHONG MAO	DATE: 12NOV2012 DATE: 12NOV2012 DATE: 12NOV2012
DIMENSIONS: mm		TOLERANCES UNLESS OTHERWISE SPECIFIED:	NAME: RAST 2.5 TAB HEADER ASSY TH, VERTICAL, EXTERNAL LOCKING
		0 PLC ± 1 PLC ± 2 PLC ±0.20 3 PLC ± 4 PLC ± ANGLES ±1° FINISH:	
MATERIAL:		WEIGHT:	RESTRICTED TO:
CUSTOMER DRAWING	SCALE: NTS	SHEET 4 OF 5	REV A.3

THIS DRAWING IS UNPUBLISHED. RELEASED FOR PUBLICATION 20
 © COPYRIGHT 20 BY - ALL RIGHTS RESERVED.

LOC	DIST	REVISIONS			
P	LTR	DESCRIPTION	DATE	DWN	APVD
ES	00	-	SEE SHEET 1	-	-

FOR ANY KEYING CONFIGURATION, THERE ARE EIGHT COLORS AVAILABLE, BESIDES THE NATURAL COLOR, THERE ARE OTHER SEVEN COLORS, INCLUDE: YELLOW, BLUE, GREY, PURPLE, RED, GREEN, BLACK. THE WHITE VERSION IS PRELIMINARY. THE P/N OF THE COLOR CONNECTOR ARE BASED ON THE NATURAL CONNECTOR, THE PREFIX AND POSTFIX ARE THE SAME FOR THE SAME KEYING CONFIGURATION, BUT THE BASE NUMBERS ARE DIFFERENT ACCORDING TO DIFFERENT COLOR. THE FOLLOWING SHOWS WHAT'S THE P/N FOR COLOR CONNECTOR

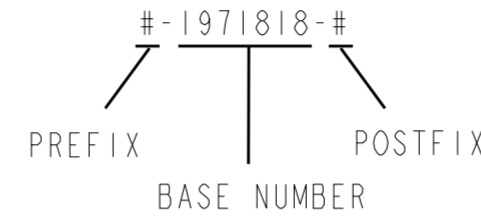

COLOR	PART NUMBER OF THE CONNECTOR				COMMENTS
	WITH TIN PLATING CONTACT		WITH AG PLATING CONTACT		
NATURAL	#-1971817-#	#-1971818-#	#-1971837-#	#-1971838-#	THE DETAIL P/N FOR DIFFERENT KEYING SEE SHEET 2 & 3 & 4
RED	#-1971938-#	#-1971939-#	#-2232141-#	#-2232142-#	THE PREFIX AND POSTFIX ARE THE SAME WITH THE P/N OF THE NATURAL CONNECTOR FOR THE SAME KEYING CONFIGURATION, JUST THE BASE NUMBERS ARE DIFFERENT BASED ON DIFFERENT COLOR. # CAN BE THE NUMBER FROM 0 TO 9.
BLUE	#-2232143-#	#-2232144-#	#-2232145-#	#-2232146-#	
YELLOW	#-2232147-#	#-2232148-#	#-2232149-#	#-2232150-#	
BALCK	#-1971994-#	#-1971995-#	#-2232151-#	#-2232152-#	
GREY	#-1971976-#	#-1971977-#	#-2232153-#	#-2232154-#	
GREEN	#-1971988-#	#-1971989-#	#-2232155-#	#-2232156-#	
PURPLE	#-2232157-#	#-2232158-#	#-2232159-#	#-2232160-#	
WHITE	#-2232277-#	#-2232278-#	#-2232279-#	#-2232280-#	

FOR EXAMPLE, IF A CONNECTOR WITH THE CONFIGURATION AS BELOW, AND WITH TIN PLATING CONTACT, IN THE SHEET 4, WE CAN FIND THE RELATED CONNECTOR P/N WITH NATURAL COLOR IS 5-1971817-4, THEN WE CAN LOOK IN THE ABOVE TABLE TO FIND THE CONNECTOR P/N WITH RED COLOR IS 5-1971938-4



THIS DRAWING IS A CONTROLLED DOCUMENT.		DWN WINTER WANG 12NOV2012	TE Connectivity	
DIMENSIONS: mm		CHK HAPYE WU 12NOV2012		
TOLERANCES UNLESS OTHERWISE SPECIFIED:		APVD YUJHONG MAO 12NOV2012	NAME RAST 2.5 TAB HEADER ASSY TH, VERTICAL, EXTERNAL LOCKING	
0 PLC ± 1 PLC ± 2 PLC ±0.20 3 PLC ± 4 PLC ±		PRODUCT SPEC 108-106079	RESTRICTED TO	
ANGLES ±° FINISH		APPLICATION SPEC	SIZE A2	CAGE CODE 00779
MATERIAL		WEIGHT	DRAWING NO C-1971817	SCALE NTS
		CUSTOMER DRAWING	SHEET 5	OF 5
			REV A3	